

JVC

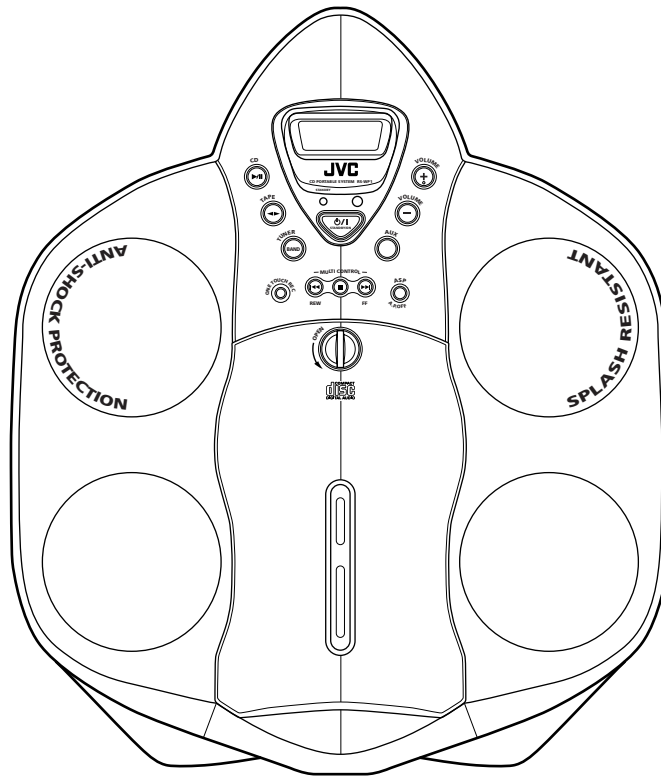

CD PORTABLE SYSTEM

RS-WP1WT

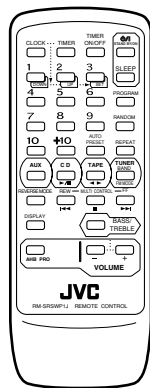

COMPACT
disc
DIGITAL AUDIO

INSTRUCTIONS

For Customer Use:

Enter below the Model No. and Serial No. which are located either on the rear, bottom or side of the cabinet. Retain this information for future reference.

Model No. _____

Serial No. _____

LVT0682-005A

[B]

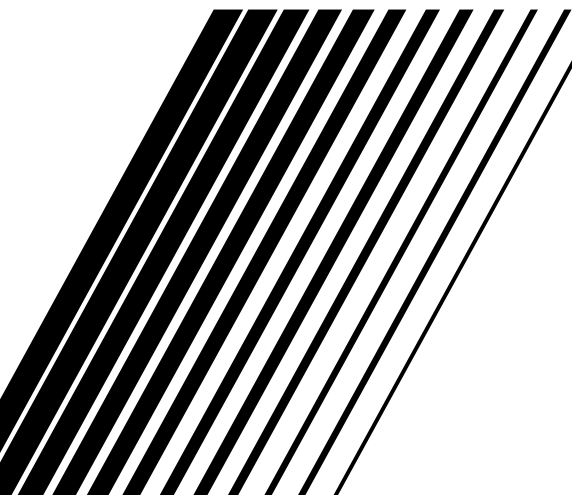

Warnings, Cautions and Others

IMPORTANT for the U.K.

DO NOT cut off the mains plug from this equipment. If the plug fitted is not suitable for the power points in your home or the cable is too short to reach a power point, then obtain an appropriate safety approved extension lead or consult your dealer.

BE SURE to replace the fuse only with an identical approved type, as originally fitted.

If nonetheless the mains plug is cut off ensure to remove the fuse and dispose of the plug immediately, to avoid a possible shock hazard by inadvertent connection to the mains supply.

If this product is not supplied fitted with a mains plug then follow the instructions given below:

IMPORTANT:

DO NOT make any connection to the terminal which is marked with the letter E or by the safety earth symbol or coloured green or green-and-yellow.

The wires in the mains lead on this product are coloured in accordance with the following code:

Blue : Neutral
Brown : Live

As these colours may not correspond with the coloured markings identifying the terminals in your plug proceed as follows:

The wire which is coloured blue must be connected to the terminal which is marked with the letter N or coloured black.

The wire which is coloured brown must be connected to the terminal which is marked with the letter L or coloured red.

IF IN DOUBT - CONSULT A COMPETENT ELECTRICIAN.

Caution — STANDBY/ON button!

Disconnect the mains plug to shut the power off completely. The STANDBY/ON  button in any position does not disconnect the mains line. The power can be remote controlled.

CAUTION

To reduce the risk of electrical shocks, fire, etc.:

1. Do not remove screws, covers or cabinet.
2. Do not expose this appliance to rain or moisture.

IMPORTANT FOR LASER PRODUCTS

REPRODUCTION OF LABELS

- ① CLASSIFICATION LABEL, PLACED ON REAR ENCLOSURE

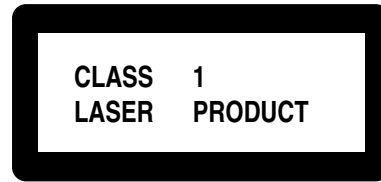

- ② WARNING LABEL, PLACED INSIDE THE UNIT

CAUTION: Invisible laser radiation when open and interlock failed or defeated. AVOID DIRECT EXPOSURE TO BEAM.	ADVARSEL: Usynlig laserstråling ved åbning, når sikkerhedsafbrydere er ude af funktion. Undgåudsætelse for stråling.	VARNING: Osynlig laserstråling når denna del är öppnad och spärren är urkopplad. Beträkta strålen.	VARO: Avattaessa ja suojalukitus ohitettaessa olet alttiina näkymättömälle lasersäteilylle. Älä katso säteeseen.
(e)	(e)	(d)	(s)

1. CLASS 1 LASER PRODUCT
2. **CAUTION:** Invisible laser radiation when open and interlock failed or defeated. Avoid direct exposure to beam.
3. **CAUTION:** Do not open the top cover. There are no user serviceable parts inside the Unit; leave all servicing to qualified service personnel.

CAUTION

- Do not block the ventilation openings or holes. (If the ventilation openings or holes are blocked by a newspaper or cloth, etc., the heat may not be able to get out.)
- Do not place any naked flame sources, such as lighted candles, on the apparatus.
- When discarding batteries, environmental problems must be considered and local rules or laws governing the disposal of these batteries must be followed strictly.
- Do not use this apparatus in a bathroom or places with water. Also do not place any containers filled with water or liquids (such as cosmetics or medicines, flower vases, potted plants, cups, etc.) on top of this apparatus.

Caution: Proper Ventilation

To avoid risk of electric shock and fire, and to prevent damage, locate the apparatus as follows:

1 Front:

No obstructions and open spacing.

2 Sides/ Top/ Back:

No obstructions should be placed in the areas shown by the dimensions below.

3 Bottom:

Place on the level surface. Maintain an adequate air path for ventilation by placing on a stand with a height of 10 cm or more.

Front view

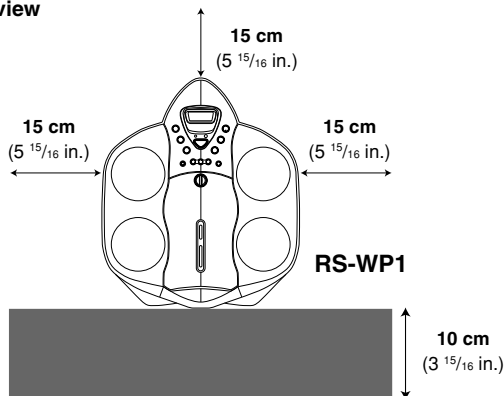

Side view

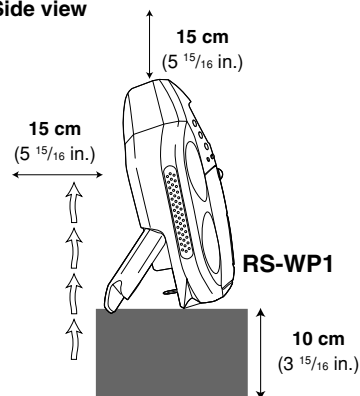

SAFETY INSTRUCTIONS

“SOME DOS AND DON'TS ON THE SAFE USE OF EQUIPMENT”

This equipment has been designed and manufactured to meet international safety standards but, like any electrical equipment, care must be taken if you are to obtain the best results and safety is to be assured.

Do read the operating instructions before you attempt to use the equipment.

Do ensure that all electrical connections (including the mains plug, extension leads and interconnections between pieces of equipment) are properly made and in accordance with the manufacturer's instructions. Switch off and withdraw the mains plug when making or changing connections.

Do consult your dealer if you are ever in doubt about the installation, operation or safety of your equipment.

Do be careful with glass panels or doors on equipment.

DON'T continue to operate the equipment if you are in any doubt about it working normally, or if it is damaged in any way — switch off, withdraw the mains plug and consult your dealer.

DON'T remove any fixed cover as this may expose dangerous voltages.

DON'T leave equipment switched on when it is unattended unless it is specifically stated that it is designed for unattended operation or has a standby mode.

Switch off using the switch on the equipment and make sure that your family know how to do this.

Special arrangements may need to be made for infirm or handicapped people.

DON'T use equipment such as personal stereos or radios so that you are distracted from the requirements of traffic safety. It is illegal to watch television whilst driving.

DON'T listen to headphones at high volume as such use can permanently damage your hearing.

DON'T obstruct the ventilation of the equipment, for example with curtains or soft furnishings.

Overheating will cause damage and shorten the life of the equipment.

DON'T use makeshift stands and NEVER fix legs with wood screws — to ensure complete safety always fit the manufacturer's approved stand or legs with the fixings provided according to the instructions.

DON'T allow electrical equipment to be exposed to rain or moisture.

ABOVE ALL

- NEVER let anyone, especially children, push anything into holes, slots or any other opening in the case — this could result in a fatal electrical shock.
- NEVER guess or take chances with electrical equipment of any kind — it is better to be safe than sorry!

Thank you for purchasing the JVC CD Portable System.

We hope it will be a valued addition to your home as well as your outdoor life, giving you years of enjoyment.

Be sure to read this instruction manual carefully before operating your new stereo system.

In it you will find all the information you need to set up and use the system.

If you have a query that is not answered by the manual, please contact your dealer.

Features

Here are some of the things that make your System both powerful and simple to use.

- Built-in 40 seconds shock proof memory (CD Player)
- Powerful bass sound by dual passive speakers
- Water drop-resist design
- Double shoulder strap and waist belt for carrying on your back
- The controls and operations have been redesigned to make them very easy to use, freeing you to just enjoy the music.
• With JVC's **COMPU PLAY** you can turn on the System and automatically start the CD Player, Cassette Deck, or Radio with a single touch. (Only when AC power or car battery (DC12V) is used.)
- A 45-station preset capability (30 FM and 15 AM) in addition to Auto Tuning and Manual Tuning.
- CD options include Program, Random and Repeat Play.
- Auto-reverse tape function
- Timer functions; set the system to automatically come on, switch off.



How This Manual Is Organized

- Basic information that is the same for many different functions - e.g. setting the volume - is given in the section 'Basic Operations', and not repeated under each function.
- The names of buttons/controls and display messages are written in all capital letters: e.g. TUNER BAND, "NO DISC".
- System functions are written with an initial capital letter only: e.g. Normal Play.

Use the table of contents to look up specific information you require.

We've enjoyed making this manual for you, and hope it serves you in enjoying the many features built into your System.

IMPORTANT CAUTIONS

1. Where to place the System

- Select a place which is level, dry and neither too hot nor too cold. (Between 0°C and 40°C)
- Leave sufficient distance between the System and a TV.
- When installing the System, completely spread the stand until it clicks to prevent the System from toppling down.
- Do not lean against the System.
- If you place the System on a desk, do not place it on the side near you.
- If you have small children in your house, do not let them play near the System or install it within the reach of children.
- Do not leave the System in a place subject to direct sunlight or a closed automobile under the sun.
- To prevent an accident, do not install the System on a high or unstable surface.
- In case a lightning storm occurs during outdoor use of the System, fold the antenna and get yourself apart from the System to avoid danger caused by lightning.

2. AC adaptor

- Do not handle the AC adaptor with wet hands!
- Some power is always consumed as long as the AC adaptor is connected to the wall outlet.
- When unplugging the System from the wall outlet, always pull the plug, not the AC adaptor cord.

3. When carrying the System

- Disconnect all the cords from the System.
- Fold the antenna and stand. Be careful not to catch your finger when folding the stand.
- Do not carry the System by holding the stand.
- Be sure to carry the System by holding the carrying handle.
- Do not use headphones while walking.
- Do not use the System while driving a vehicle, etc.

4. Malfunctions, etc.

- There are no user serviceable parts inside. In case of System failure, unplug the AC adaptor and consult your dealer.
- Do not insert any metallic object into the System.

Table of Contents

Features	2	Using the Cassette Deck (Listening to a Tape)	13
How This Manual Is Organized	2	Using the Cassette Deck (Recording)	14
IMPORTANT CAUTIONS	2	Listening to an Auxiliary Equipment	16
Getting Started	3	Using the Timers	17
Basic Operations	7	Care And Maintenance	19
Using the Tuner	9	Troubleshooting	20
Using the CD Player	11	Specifications	21

Getting Started

Accessories

Check that you have all of the following items, which are supplied with the System.

- AC adaptor (1)
- Remote Control (1)
- Batteries R6P (SUM-3)/AA (15F) (2)
- Shoulder Strap (1)

If any of these items are missing, contact your dealer immediately.

How To Carry the System

To carry the System, attach the supplied shoulder strap to the System as shown in the figure.

To remove the strap, reverse the attaching procedure.

The shoulder strap is adjustable in length and has the remote control case.

Finished view

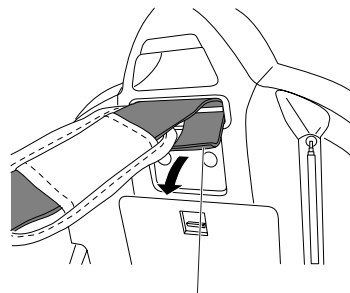
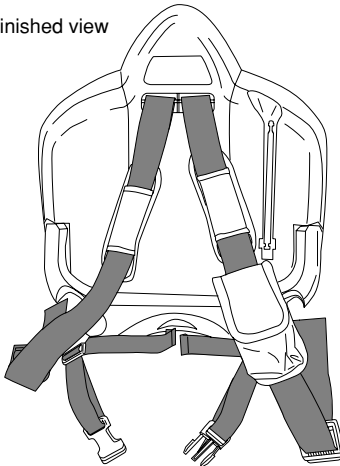

Pass the extremity of the strap through the shaft by inserting the strap from the upper side of the shaft.

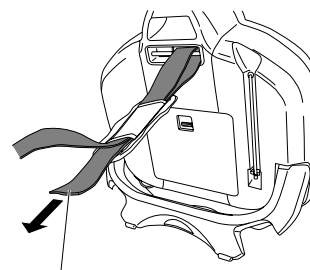

Pass the extremity of the strap through the shoulder pad.

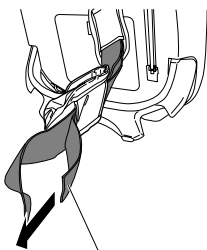

Pass the extremity of the strap through the remote controller holder (left shoulder side only).

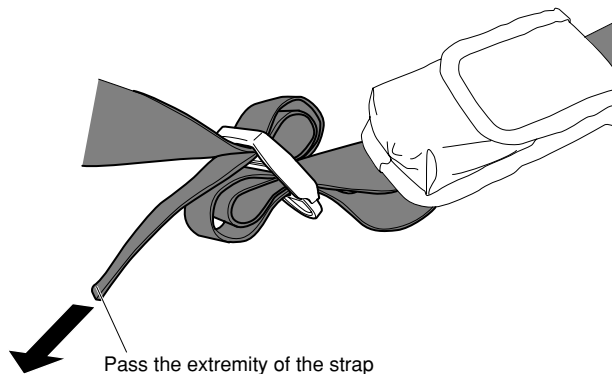

Pass the extremity of the strap through the adjuster. Adjust the strap length by adjusting the extremity.

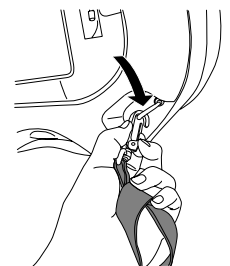

Press in the metal fitting of the shoulder strap and hook it over the shaft.

Adjust the strap length by adjusting the extremity.

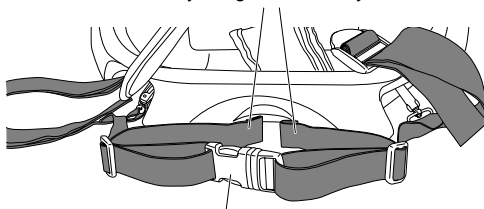

Fit and fasten the connector.

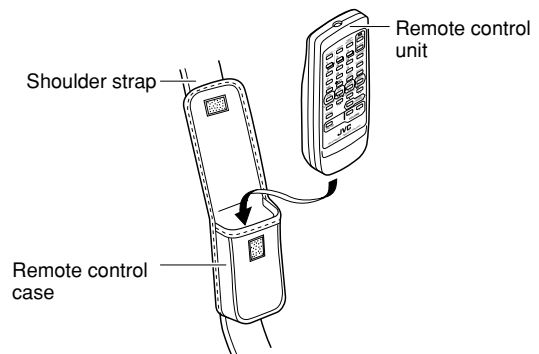

Notes:

- To prevent hazards, do not let a small child carry the unit on the back.
- To prevent hazards, do not act violently while you carry this System on your back. Also be sure to tighten the belt firmly.
- Do not carry the System on your naked back.
- The waist belt corresponds to waist 120 cm or less.

How To Put Batteries In the Remote Control

Match the polarity (+ and -) on the batteries with the + and - markings in the battery compartment.

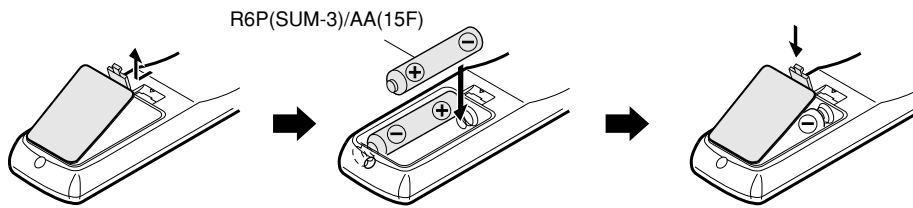

CAUTION: Handle batteries properly.

To avoid battery leakage or explosion:

- Remove batteries when the Remote Control will not be used for a long time.
- When you need to replace the batteries, replace both batteries at the same time with new ones.
- Don't use an old battery with a new one.
- Don't use different types of batteries together.

Using the Remote Control

The Remote Control makes it easy to use many of the functions of the System.

You need to point the Remote Control at the remote sensor on the System's front panel within 7 m or another remote sensor on the System's rear panel within 1 m. When remote controlling this Unit while carrying it piggyback, point the Remote Control to the remote sensor on the rear panel.

Notes:

- If you point the Remote Control from the slant direction, the above distance will be shortened.
- When you use the Remote Control from a short distance while receiving broadcasting, noise may occur. However, this is not malfunction.
- The Remote Control of this Unit uses the infrared transmission system. As a result, Remote Control may be unavailable when the remote sensors of the Unit are exposed to direct sunlight. Please note that this is not a malfunction.

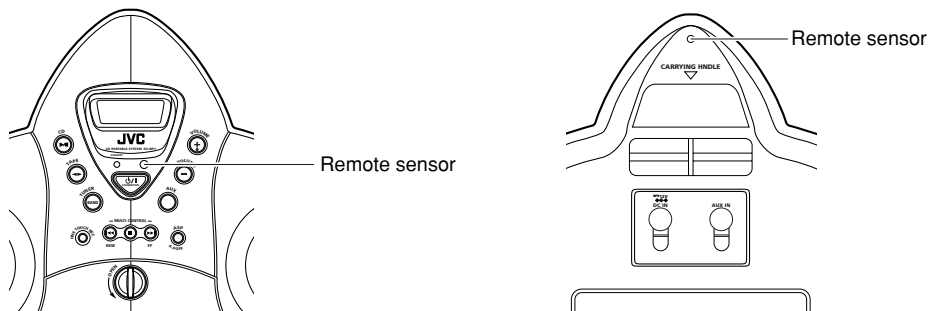

Connecting Auxiliary Equipment

Connect a signal cord (not supplied) between the AUX IN terminal on the back of the System and the output terminals of your auxiliary equipment (e.g. turntable or MD player). You can listen to this source.

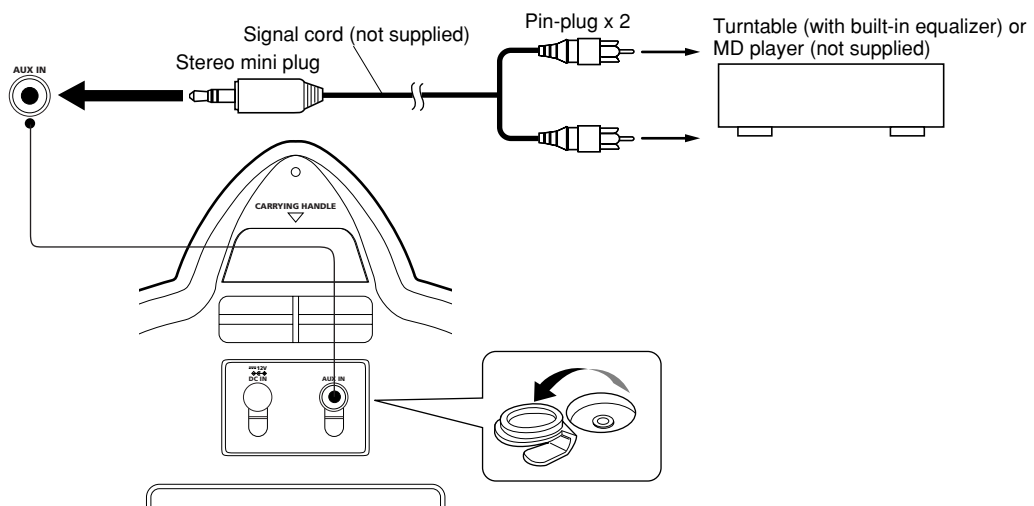

CAUTION: Make all connections before plugging the System into an AC power outlet.

Connecting the AC Adaptor Cord

Firmly insert the supplied AC adaptor cord into the DC IN jack on the back of the System.

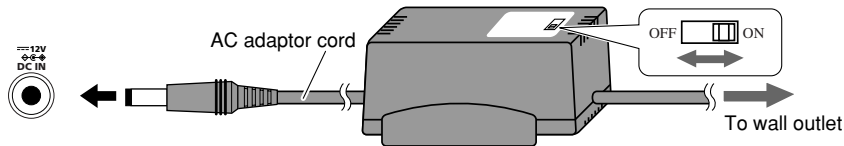

Note:

This Unit may generate noise depending on the positioning of the AC adaptor. Place the Unit and AC adaptor as shown in the figure.

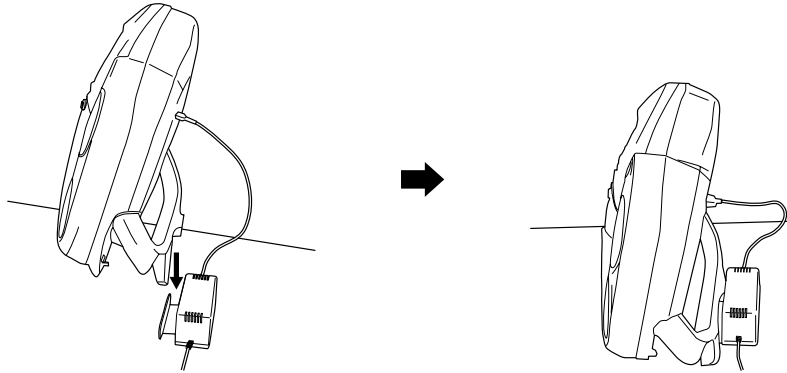

CAUTIONS:

- **ONLY USE THE JVC AC ADAPTOR PROVIDED WITH THIS SYSTEM TO AVOID MALFUNCTION OR DAMAGE TO THE SYSTEM.**
- **BE SURE TO UNPLUG THE AC ADAPTOR FROM THE OUTLET OR SET THE SWITCH ON THE AC ADAPTOR TO THE OFF POSITION WHEN GOING OUT OR WHEN THE SYSTEM IS NOT IN USE FOR AN EXTENDED PERIOD OF TIME.**

Now you can plug the AC adaptor into the wall outlet, and your System is at your command!!

How To Operate the System on Batteries

You can operate the System on 8 batteries.

- 1. Open the battery cover on the back of the System by pulling it toward you while pressing the tab.**
- 2. Put 8 batteries (not supplied) in the battery compartment.**
 - Match the polarity (+ and -) on the batteries with the + and - marking in the battery compartment.
- 3. Securely close the battery cover while pressing the tab.**

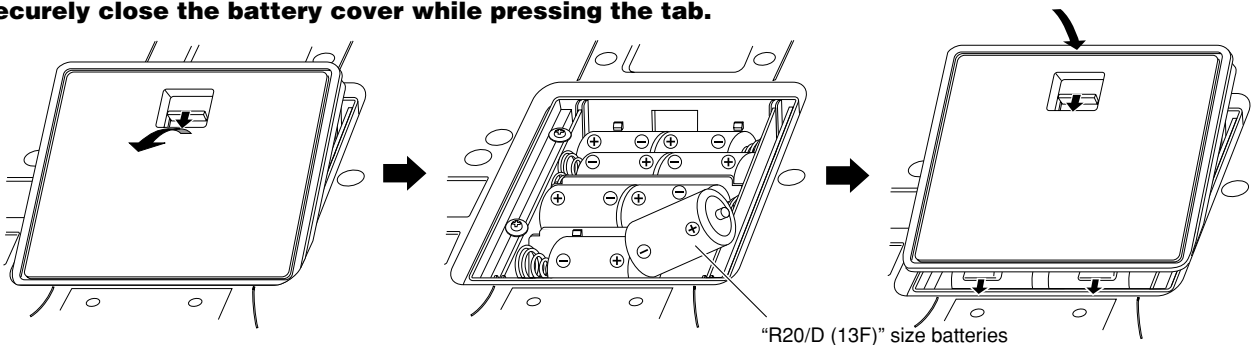

Notes:

- When you operate the System on AC power or car battery (DC12V), the power source automatically switches from batteries to AC or DC12V. However, you should remove the 8 batteries when operating on AC power or car battery (DC12V).
- When the batteries are exhausted, mistracking will occur during CD playback or sound will be distorted intermittently during tape playback. You need to replace the batteries at a time.
- It is recommended that the AC adaptor be used when recording important material or listening to a CD.
- When inserting batteries in the System, lay it on a soft surface so as not to damage it and facilitate insertion.

CAUTION: Handle batteries properly.

To avoid battery leakage or explosion:

- Remove 8 batteries when the System will not be used for a long time.
- When you need to replace the batteries, replace all batteries at the same time with new ones.
- Don't use an old battery with new ones.
- Don't use different types of batteries together.

How To Operate the System on Car Battery (DC12V)

You can operate the System on car battery (DC12V).

- 1. First, connect the car adaptor to the DC IN jack on the back of the System, to avoid a short-circuit of the car adaptor.**
- 2. Next, connect the car adaptor to the cigarette lighter socket (DC12V) of the car.**

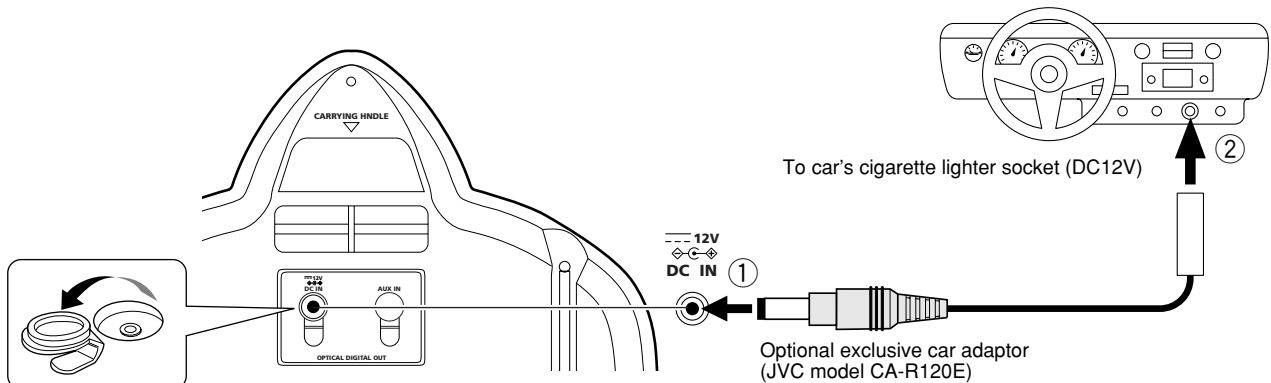

CAUTION: Use the System in a car properly.

- Be sure to use the specified car adaptor (JVC model CA-R120E) to prevent mishaps or damage resulting from different polarity design.
- For safety, stop the car before performing operations.
- Be sure to start the engine when you use the car adaptor, otherwise the car battery will be exhausted.
- During transport, stabilize the System in a box, etc.
- To prevent malfunctions, do not leave the System in a car for a long time.

Attaching the removed door

To prevent the unit from toppling down accidentally, the door has been designed to come off when it is pushed with a strong force from the upper direction while it is open. When the door comes off in this way, attach it as shown in the figure.

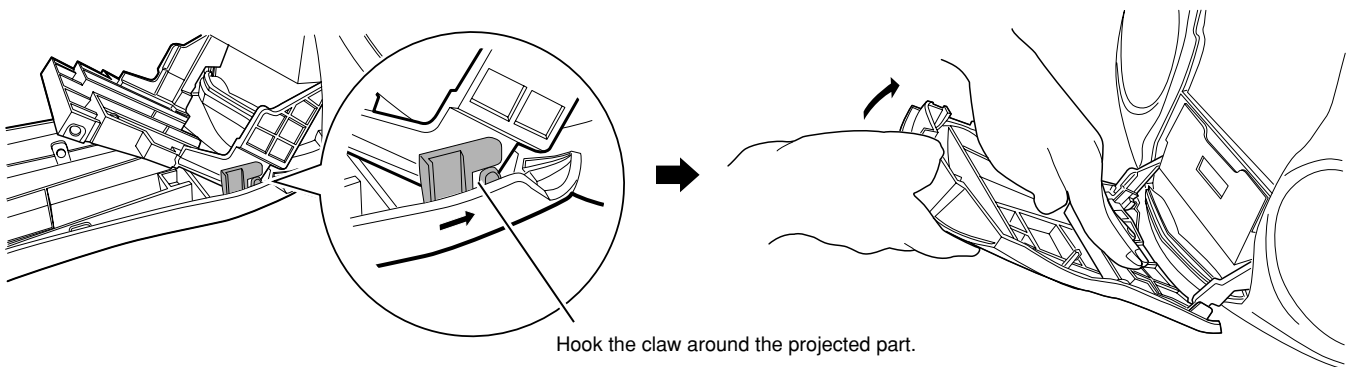

COMPU PLAY

JVC's COMPU PLAY feature lets you control the most frequently used System functions with a single touch.

With One Touch Operation you can play a CD, a tape, or turn on the radio with a single press of the play button for that function. One Touch Operation turns the power on for you, then starts the function you have specified. If the System is not ready (no CD in place, for example), the System still powers on so you can insert a CD.

How One Touch Operation works in each case is explained in the section dealing with that function.

The COMPU PLAY buttons are:

On the Unit

- CD ►/|| button
- TAPE ◀▶ button
- TUNER BAND button
- AUX button

On the Remote Control

- CD ►/|| button
- TAPE ◀▶ button
- TUNER BAND button
- AUX button

Note:

The COMPU PLAY feature is ineffective when the System is operated on batteries.

Basic Operations

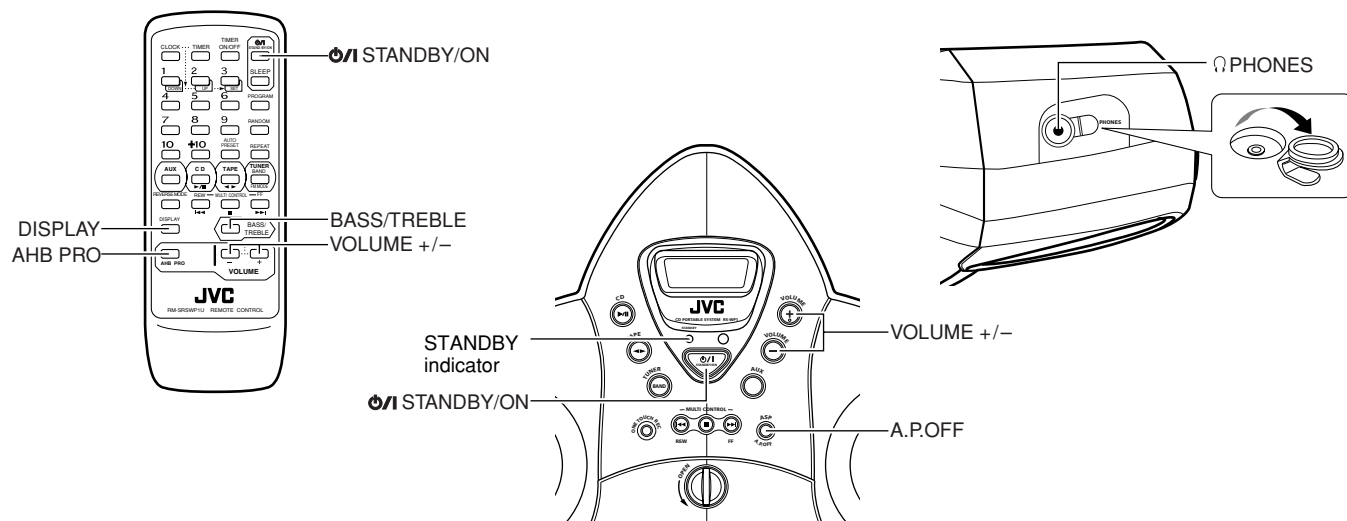

Turning the Power On and Off

Note:

The lighting condition for the “STANDBY” indicator and the display differs depending on the power source being used, as follows:

Power source	“STANDBY” indicator/Display
AC power or car battery (DC12V)	<ul style="list-style-type: none"> The “STANDBY” indicator lights when the power is turned off. Backlighting of the display is illuminated when power is turned on.
Batteries	<ul style="list-style-type: none"> The “STANDBY” indicator does not light. Backlighting of the display is not illuminated. However, the backlighting is illuminated for a few seconds after operation.

Turning the System On

Press the **⏻/I STANDBY/ON** button on the Unit or the Remote Control.

- When the System is operated on batteries, press the **⏻/I STANDBY/ON** button on the Unit. It cannot be turned on with the Remote Control.

The “STANDBY” indicator goes out when the System is operated on AC power or car battery (DC12V).

The display comes on and the System is ready to continue in the mode it was in when the power was last turned off.



- For example, if the last thing you were doing was listening to a CD, you are now ready to listen to a CD again. If you wish, you can change to another source.
- If you were listening to the Tuner last, the Tuner comes on playing the station it was last set to.

Turning the System Off

Press the **⏻/I STANDBY/ON** button again.

The “STANDBY” indicator lights up when the System is operated on AC power or car battery (DC12V).

The contents of the display changes to the clock, and “CLOCK” indicator and the time are displayed without backlighting.

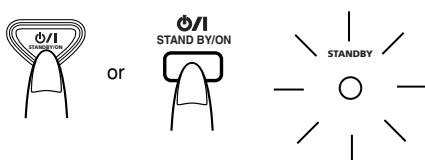

- Some power is always consumed even though power is turned off (called Standby Mode).
- To switch off the System completely, unplug the AC adaptor from the AC outlet. If no battery is loaded in the System and it left with the AC adaptor unplugged (or when there is a power failure) for more than 5 minutes, the clock will be reset to “0:00”.

AUTO POWER OFF function

This System incorporates the AUTO POWER OFF function which automatically turns the System off when no sound has been produced for more than 10 minutes. In consequence, when 10 minutes have elapsed without any operation after completion of CD or Tape operation, the power of the System is turned off automatically.

When the playback or recording operation is performed within 10 minutes, the count by the AUTO POWER OFF function is disabled, but it starts again as soon as the playback or recording completes. When operations other than playback or recording is performed, the count by the AUTO POWER OFF function starts after the last operation of this kind, and the system is turned off in 10 minutes if no more operation is performed.

At 1 minute before the system is turned off by the AUTO POWER OFF function, message “P.OFF” blinks in the display.

The AUTO POWER OFF function is not available in Tuner mode or AUX mode.

To enable the AUTO POWER OFF function

Press the A.P.OFF button on the Unit for more than two seconds so that “A.P.OFF” appears in the display.

To disable the AUTO POWER OFF function

Press the A.P.OFF button on the Unit for more than two seconds so that “A.P.OFF” disappears from the display.

Adjusting the Volume

You can adjust the volume level between 0 and 50.

VOL 7

Press the VOLUME + button to increase the volume or press the VOLUME – button to decrease it.

When you keep pressed the VOLUME + or – button, the volume changes rapidly.

CAUTION: DO NOT start playing any source without first setting the volume to minimum, as a sudden blast of sound can damage your hearing, speakers and/or headphones.

For private listening

Connect a pair of headphones to the PHONES jack. No sound comes out of the speakers.

Be sure to turn down the volume before connecting or putting on headphones.

Note:

Do not pull the headphone cord with a strong force when headphones are connected to the System. Otherwise, the System may fall down.

Active Hyper Bass Pro

You can enhance the bass level. You can use this effect only for playback.

Press the AHB PRO button on the Remote Control.

Each time you press the button, the display changes as follows:

BASS 1 → BASS 2 → OFF → (back to the beginning)

BASS indicator appears on the display.

Tone Control (BASS/TREBLE)

You can control the tone by changing the bass and the treble between –5 and +5. (0: Flat)

1. Press the BASS/TREBLE button on the Remote Control to select BASS or TREBLE.

Each time you press the button, the display changes as follows:

BASS → TREBLE → Current sound source → (back to the beginning)

2. Press the VOLUME + or VOLUME – button within five seconds to adjust the bass or treble level.



(Within 5 seconds)

BAS -5 BAS +5

TRE -5 TRE +5

Showing the Time (DISPLAY)

In Standby mode, the backlight of the display goes out, and the “CLOCK” indicator and the current time (clock) appear on the display.

While the power is turned on, you can see the current time (clock) at any time, as follows:

Press the DISPLAY button on the Remote Control.

Each time you press the button, the display changes as follows:

Current sound source (e.g. FM103.5 MHz) → **Clock** → (back to the beginning)

Note:

To let work the clock, you need to set the clock first. (See “Setting the Clock” on page 17.)

Using the Tuner

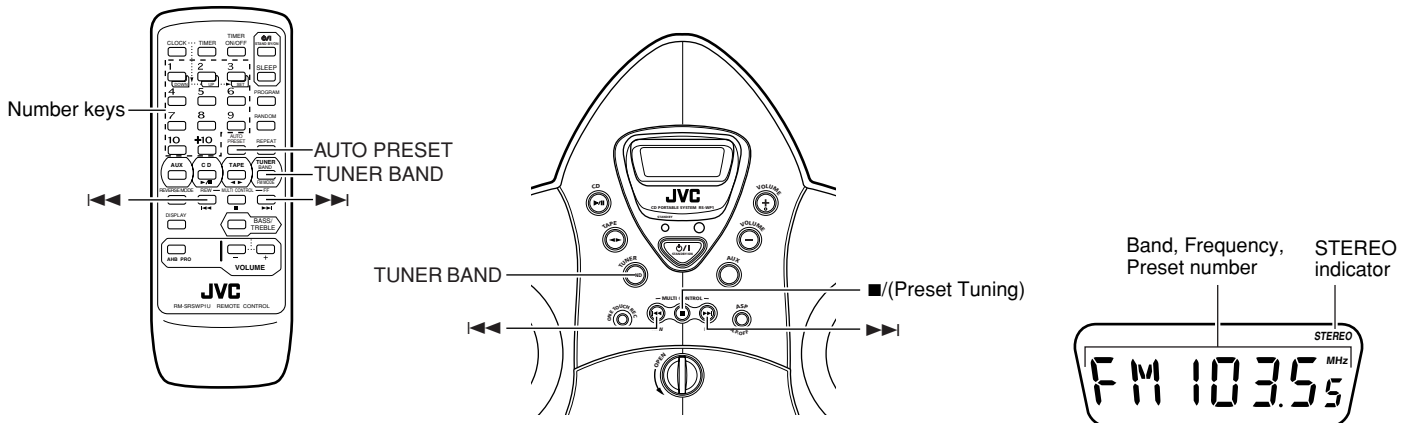

You can listen to FM and AM stations. Stations can be tuned in manually, automatically, or from preset memory storage.

■ **Before listening to the radio:**

- Fully extend the FM telescopic antenna.

One Touch Radio

- This operation is effective only when the System is operated on AC power or car battery.

Just press the TUNER BAND button to turn on the System and start playing the station you were last tuned to.

- You can switch from any other sound source to the radio by pressing the TUNER BAND button.

Tuning In a Station

1. Press the TUNER BAND button.

The Band and Frequency you were last tuned to appear on the display.

Each time you press the button, the band and FM mode change as follows:

FM → **FM-MONO** → **AM** → (back to the beginning)

- When you tune in an FM broadcast in FM mode, the "STEREO" indicator lights up and you can hear stereo effects. If an FM stereo broadcast is hard to receive or noisy, select FM-MONO mode. The "STEREO" indicator will go out. Reception improves, but you lose any stereo effect.

2. Select a station using one of the following methods.

■ **Manual Tuning**

Press the ◀◀ or ▶▶ button repeatedly to move from frequency to frequency until you find the station you want.

OR

■ **Auto Tuning**

If you press and hold the ◀◀ or ▶▶ button for one second or more, the frequency changes down, or up, automatically until a station is found.

OR

■ **Preset Tuning (Possible only after presetting stations)**

Select the desired preset number (displayed as "P-XX" on the display) using the ■ button on the Unit or the number keys on the Remote control. After 1 second, the display will show the preset number's band and frequency.

P-12 → FM 103.55

On the Unit

- **button:** Each time you press the button, the preset number increases.

On the Remote Control

- Number keys:** To select P-5, press 5.
To select P-15, press +10 then 5.
To select P-20, press +10 once then press 10.

3. Turn the FM antenna for the best reception.

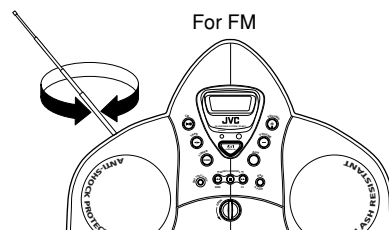

For an AM broadcast, turn the Unit to obtain the best reception. Placing the Unit near the window, for example, will improve AM reception.

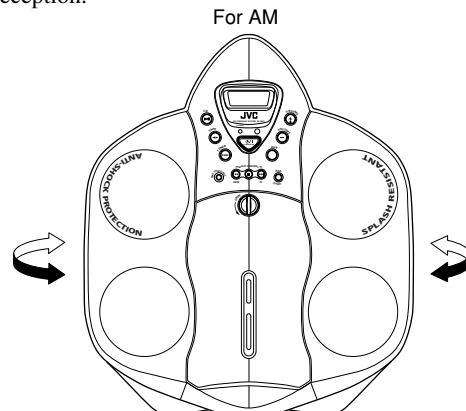

Note:

When transporting the System, fold and store the antenna in place before carrying the System on your back.

Presetting Stations

You can preset up to 30 FM stations and up to 15 AM stations.

Note:

Preset numbers may have been set to factory test frequencies prior to shipment. This is not a malfunction. You can preset the stations you want into memory by following one of the presetting methods below:

Manual Presetting

1. **Select a band (either AM or FM/FM-MONO) by pressing the TUNER BAND button.**



2. **Press the <<< or >>> button to tune in a station.**

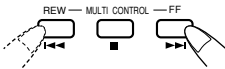

3. **Press the number key for more than 3 seconds to store in memory for the desired preset number.**

The preset number blinks for four seconds and then the preset station for the preset number appears.

Example: To preset the tuned station to the preset number 15, press +10 then 5 for more than 3 seconds. The display changes as follows.

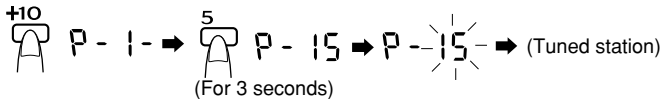

4. **Repeat above steps 1 to 3 for each station you want to store in memory with a preset number.**

To change the preset stations, repeat the same steps as above to overwrite a new station.

Auto Presetting

In each band, you can automatically preset FM-30, AM-15 stations. Preset numbers will be allocated as stations are found, starting from the lowest station and moving up the frequency.

1. **Select a band (either AM or FM/FM-MONO) by pressing the TUNER BAND button.**



2. **Press the AUTO PRESET button on the Remote Control for more than 2 seconds.**

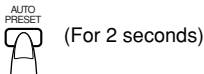

3. **Repeat steps 1 and 2 for the other band.**

- If you want to change the preset stations, carry out the Manual Presetting for the desired preset numbers.

CAUTION: If no battery is loaded in the unit and it left with the AC adaptor unplugged (or when there is a power failure) for more than 24 hours, preset stations will be eliminated. Store all stations again after connecting the AC adaptor cord (or after electric power failure restores).

Using the CD Player

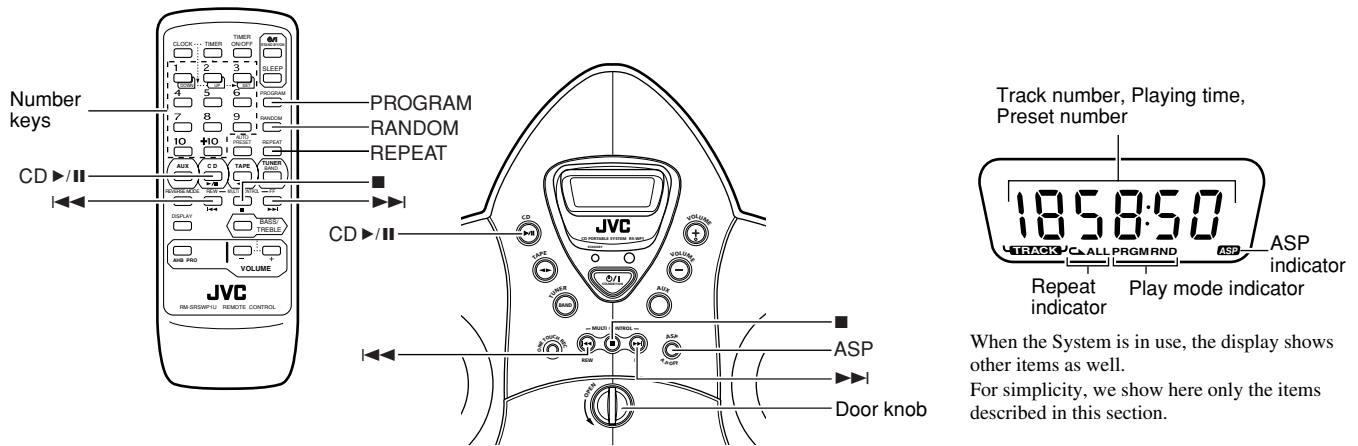

You can use Normal, Program, Random or Repeat Play. Repeat Play can repeat all the tracks or just one of the tracks on the CD.

Here are the basic things you need to know to play a CD and locate the different tracks on it.

The Quickest Way To Start a CD Is With the One Touch Operation (effective only when the System is operated on AC power or car battery (DC12V))

- Press the CD ►/|| button.
 - The power is automatically turned on. If a CD is already inserted, it will start playing from the first track.
 - If no CD is inserted, "NO DISC" appears on the display and the CD Player remains in Stop mode.
 - When the System is operated on batteries, press the **⏻/I** STANDBY/ON button on the Unit before operation.

Setting a CD

1. Turn the door knob counterclockwise to open the door.
2. Hold the CD with its label side as shown below and push fit it in place until it clicks.

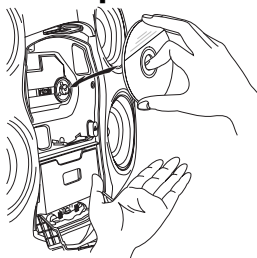

3. Close the door until it clicks.
 - To remove the CD, open the door in Stop mode.
- You can place an 8 cm (3") CD without an adaptor.
- If the CD cannot be read correctly (because it is scratched, for example), "no disc" appears on the display.
- You can place a CD while listening to the other source.

Basics of Using the CD Player-Normal Play

To Play a CD

1. Set a CD.
2. Press the CD ►/|| button.
 - The first track of the CD begins playing.



- The CD Player automatically stops when the last track of the CD has finished playing.

To stop playing the CD, press the ■ button. The following information for the CD is displayed.



To pause, press the CD ►/|| button. The playback time blinks on the display.

To cancel pause, press the same button again. Play continues from the point where it was paused.

Note:

Do not open the CD cover during playback.

Locating a Track with Remote Control Directly

During playback or in Stop mode, press the number keys on the Remote Control to directly play a track.

To directly play the track 5, press 5.

To directly play the track 15, press +10 then 5.

To directly play the track 20, press +10 once then press 10.

A.S.P. (Anti-Shock Protection)

To minimize skipping of audio due to vibrations, all audio data (for up to 40 sec.) is stored in the buffer so as to use it in case audio skipping is going to occur.

To enable A.S.P.:

Press the ASP button during stop or playback so that the "ASP" indicator appears in the display.

To disable A.S.P.:

Press the ASP button again so that the "ASP" disappears from the display.

Notes:

- When the A.S.P. function is enabled, the audio data in the CD section to be played is read in advance with a rotation speed which is slightly higher than the standard speed, and stored in a buffer. As a result, this causes the battery power to consume faster than usual.
- Every time the ASP button is pressed, the played sound is interrupted. However, this is due to the change in the rotation speed and not a malfunction.
- The sound may skip at high volume levels if the disc is scratched or stained or depending on the recorded signal. In such a case, switch the A.S.P. function ON.

To Select a Track

During playback, press the **◀◀** or **▶▶** button to select the track you want.

The selected track starts playing.

- Press the **▶▶** button once to skip to the beginning of the next track.
- Press the **◀◀** button to skip to the beginning of the track being played. Press the **◀◀** button twice quickly to skip to the beginning of the previous track.

You can also select a track in Stop mode with the same buttons. When the button is pressed, the selected track and its playback time appear on the display. To play the CD after selecting a track, just press the **▶/||** button.

Search Play

Holding down the **◀◀** or **▶▶** button, during playback, will fast forward/backwards the CD so you can quickly find a particular passage in the track you are listening to. During Search Play, you can hear the sound of approx. one forth level.

Programming the Playing Order of the Tracks

You can program the playing order of the tracks using the Remote Control.

- You can program up to 20 tracks in any desired order including the same tracks.
- You can only make a program when the CD Player is stopped.

- 1. Set a CD.**
- 2. Press the **▶/||** button to set the System function to CD.**
If the System function is already set to CD, go to step 4.
- 3. Press the **■** button to stop the CD.**
- 4. Press the **PROGRAM** button.**

The System enters the programming mode and the "PRGM" indicator lights up.

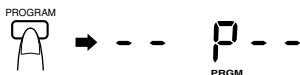

- 5. Press the number keys to select the track to program.**

To select the track 5, press 5.

To select the track 15, press +10 then 5.

To select the track 20, press +10 once then press 10.

Example: for track 2, press 2.

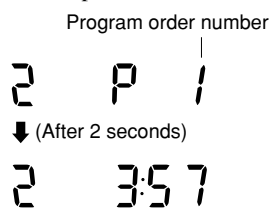

- 6. Repeat step 5 to select the other tracks for the program.**

You can see the total playback time of the programmed tracks on the display.

- To cancel the last track programmed, press the **■** button once.

- 7. Press the **▶/||** button.**

The System plays the tracks in the order you have programmed them.

- You can skip to a particular program track by pressing the **◀◀** or **▶▶** button during Program Play.

To confirm the programmed tracks while the CD player is stopped, each press the **◀◀** or **▶▶** button; the tracks making up the program successively will be displayed in the programmed order.

To delete all the tracks in the program, press the **■** button on the Remote Control repeatedly until all the tracks are cleared. Turning off the power or opening the door will also clear the programmed tracks.

To exit Program mode, while the CD Player is stopped, press the **PROGRAM** button to turn off the "PRGM" indicator. To restore Program mode, in Stop mode, press the same button to light on the "PRGM" indicator.

Notes:

- If the total playback time of the programmed tracks exceeds 99 minutes 59 seconds, "--:--" appears on the display.
- When the CD contains more than 21 tracks:
When you try to program a track number exceeding 20 (for example the 25th track), the total playback time indication will go out, though programming is possible.

To Modify the Program

Modify the contents of the program while the CD Player is stopped. Each time you press the **■** button, the last track in the program is deleted. To add new tracks to the end of the program, repeat above steps 5 and 6.

Random Play

The tracks will play in no special order when you use this mode.

- 1. Press the **RANDOM** button on the Remote Control.**

The "RND" indicator lights up on the display.

- 2. Press the **▶/||** button.**

The tracks are played in random order once.

To skip a track during playback, press the **▶▶** button to jump to the next track in the random sequence. Press the **◀◀** button to jump back to the start of a track being played.

To exit Random Play mode, press the **RANDOM** button to turn off the "RND" indicator after pressing the **■** button to stop the CD Player, or turn off the power.

Repeating Tracks

You can repeat the tracks or individual track as many times as you like.

Press the **REPEAT** button on the Remote Control.

The Repeat indicator changes with each press of the button, as shown below.

☐ → ☐ **ALL** → blank display → (back to the beginning)

☐: Repeats one track.

☐ **ALL**: In Normal Play mode, repeats all the tracks.

In Program Play mode, repeats all the tracks in the program.

In Random Play mode, repeats all the tracks in random order.

To exit Repeat mode, press the **REPEAT** button until the Repeat indicator on the display goes out.

- In Random Play, ☐ cannot be selected.
- Repeat mode remains in effect even when you change the play mode.

Using the Cassette Deck (Listening to a Tape)

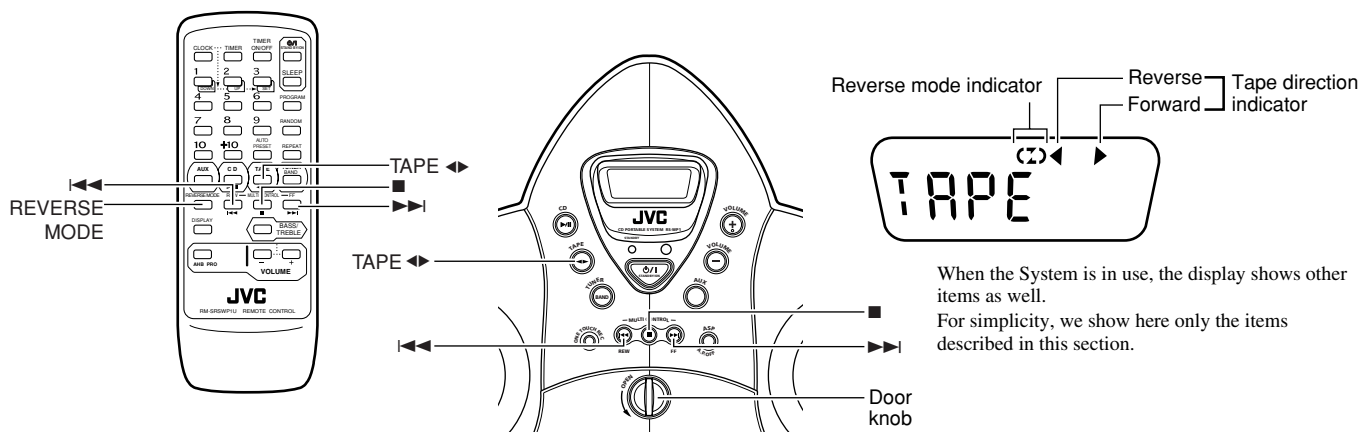

When the System is in use, the display shows other items as well. For simplicity, we show here only the items described in this section.

The Cassette Deck allows you to play and record audio tapes.

- With Automatic Tape Detection, you can listen to type I, II or IV tapes without having to change any settings.

The use of tapes longer than 120 minutes is not recommended, since characteristic deterioration may occur and these tapes easily jam in the pinch-rollers and the capstans.

One Touch Play

This operation is effective only when the System is operated on AC power or car battery (DC12V).

By pressing the TAPE button on the System or the Remote Control, the System will come on, "TAPE" appears on the display, and if a tape is in the deck, it will start to play. If no tape is loaded, insert a tape, or select other function.

Regular Play

When the power is already on, you can use this basic procedure:

- Turn the door knob counterclockwise to open the door, and press the button to open the cassette holder.
- Put the cassette in, with the side you want to listen facing toward you.

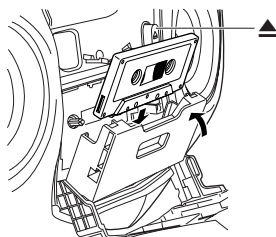

- Push the holder to close, and close the door gently until it clicks.
- Press the TAPE button.

The tape is played in the direction shown by the Tape Direction indicator. The Tape Direction indicator (Forward) or (Reverse) blinks slowly.

(Forward playback):

The side of the tape facing you is played back.

(Reverse playback):

The opposite side of the tape is played back.

- If you need to change the playback direction, press the TAPE button.

The opposite side Tape Direction indicator lights up and the tape playback direction changes.

To stop playing, press the button.

To remove the tape, stop the tape, open the door by turning door knob counterclockwise, and open the cassette holder by pressing the button.

To Fast-Wind A Tape

Press the button to fast-wind the tape. The Tape Direction indicator or will rapidly blink on the display.

- The Cassette Deck automatically stops when the tape reaches its end.

The following table shows the relationship between the Tape Direction indicator and the actual tape travelling direction in each mode. The tape travelling direction is indicated by the blinking indicator.

[Tape Direction indicator and tape travelling direction in each mode]

	Stop	Playback	FF	REW
Forward	▶	▶ (Slow)	▶ (Rapid)	▶ (Rapid)
Reverse	◀	◀ (Slow)	◀ (Rapid)	◀ (Rapid)

*Blinking indicator shows the tape travelling direction.

Reverse Mode

You can set a tape to play just one side, both sides in succession, or both sides continuously.

Press the REVERSE MODE button on the Remote Control.

Each time you press the button, the Reverse mode indicator changes as follows:

→ → → → (back to the beginning)

: The Cassette Deck automatically stops after playing one side of the tape.

: The Cassette Deck automatically stops after playing both sides of the tape. (Stops when playback in the reverse direction is finished.)

: The Cassette Deck continues to play both sides of the tape until the button is pressed.

Using the Cassette Deck (Recording)

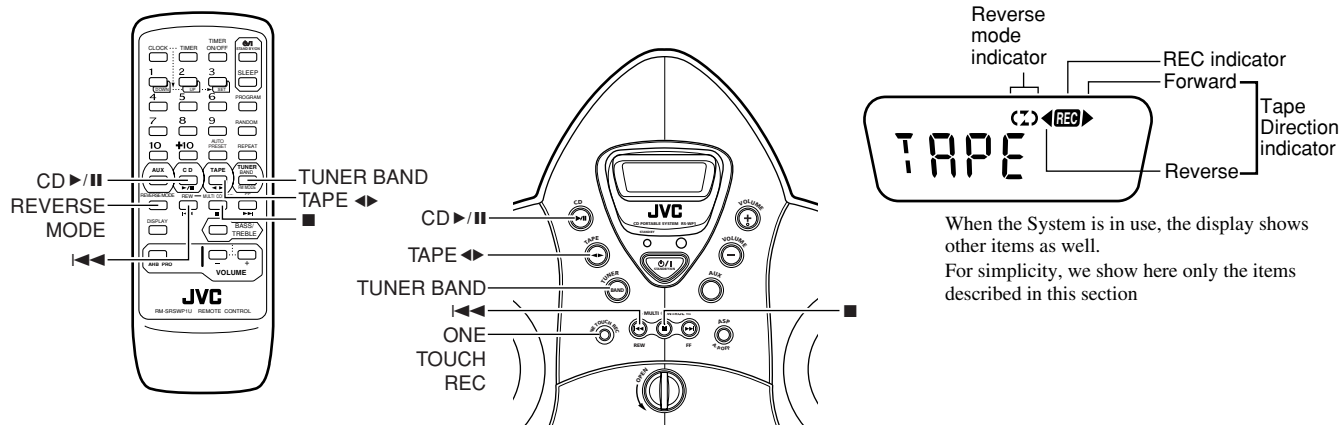

Recording onto a tape from any of the sound sources is simple. Just place a tape in the Cassette Deck, have the source ready, make one or two settings, and you're ready to record. For each source the procedure is a little bit different so we explain each separately. But first, here are a few things to make your recordings better.

CAUTION: If a recording you make has excessive noise or static, the System may have been too close to a TV which was on during the recording. Either turn off the TV or increase the distance between the TV and the System.

Things To Know Before You Start Recording

- It should be noted that it may be unlawful to re-record pre-recorded tapes, records, or discs without the consent of the owner of copyright in the sound or video recording, broadcast or cable program and in any literary, dramatic, musical, or artistic work embodied therein.
- Type I and Type II tapes can be used for recording.
- When you want to record onto both sides of a tape, you can set Reverse mode to do so. Recording automatically stops after recording in the reverse (◀) direction. Therefore, make sure that the tape direction is forward (▶) when recording with Reverse mode on.
- The recording level, which is the volume at which the new tape is being made, is automatically set correctly, so it is not affected by the VOLUME control on the System. Nor is it affected by adjusting the sound effects. Thus, during recording you can adjust the sound you are actually listening to without affecting the recording level.
- Two small tabs on the back of the cassette tape, one for side A and one for side B, can be removed to prevent accidental erasure or recording.
- To record on a cassette with the tabs removed, you must cover the holes with adhesive tape first. However, when a type II tape is used, only cover part of the hole as shown, since the other part of the hole (Type II detection slot) is used to detect the tape type.

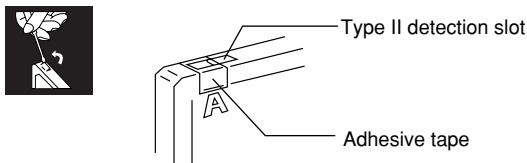

- Protect the System against vibrations during recording.
- If you record on a tape with the volume level kept at a high level, recorded sounds may be distorted. To avoid this, turn down the volume level before you start recording.

Standard Recording

You can record any sound source to tape. The sources are CD, Tuner and auxiliary equipment.

1. Insert a blank or erasable cassette tape into the Cassette Deck.

Be sure that the Tape Direction indicator and the tape insertion direction are as follows:

[Forward recording]

Tape Direction indicator	Tape insertion direction
▶ (Forward)	 (Front view)

- * Recording will be made on the tape side facing you.
- If the Tape Direction indicator ◀ (Reverse) is lit, press the TAPE ◀▶ button twice to change the direction. (In this case, since the tape is played, you need to press the ■ button.) Then, press the ◀◀ button to rewind the tape.
- If the inserted tape is not fully rewound, press the ◀◀ button to rewind it.
- At the start and end of cassette tapes, there is leader tape which cannot be recorded onto. Thus, before recording, wind on the leader tape first to ensure getting the beginning of the recording.

2. If you want to record on both sides of the tape, press the REVERSE MODE button on the Remote Control to set the System in Reverse mode.

Press the button until **Z** indicator is lit.

Even when the reverse mode is set to **Z** before starting recording, the tape stops automatically at the end of the reverse side of tape. **Z** is indicated during recording.

3. Prepare the source, by, for example, tuning in a radio station or turning on the connected auxiliary equipment.

Note:

For CD recording, refer to “CD Direct Recording” described below.

4. Press the ONE TOUCH REC button on the Unit for more than two seconds.

The “REC” indicator lights up and the System starts recording.

- If the tab of the cassette tape is removed to protect erasure or recording, recording does not start.

TIP:

When you want to record in the reverse direction, you should set the Tape Direction indicator and the cassette tape as follows in step 1. Next, start from step 3.

[Reverse recording]

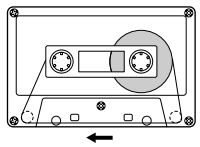
Tape Direction indicator	Tape insertion direction
	 (Front view)

*Recording will be made on the opposite side tape.

To stop at any time during the recording process

Press the **■** button.

Recording an AM station to tape —

When recording an AM broadcast, beats may be produced which are not heard when listening to the broadcast. If this happens, press the ASP button on the Unit to eliminate the beats.

1. Set to AM station and start recording.

2. Press the ASP button to eliminate the beats.

Each time you press the button, the display changes as follows:

CUT-1 → **CUT-2** → **CUT-3** → **CUT-4** → (back to the beginning)

CD Direct Recording

Everything on the CD goes onto the tape in the order it is on the CD, or according to the order you have set in a program.

1. Insert a blank or erasable cassette tape into the Cassette Deck.

Be sure that the Tape Direction indicator and the tape insertion direction are as follows:

(For details, refer to step 1 in “Standard Recording” on page 14.)

2. If you want to record on both sides of the tape, press the REVERSE MODE button on the Remote Control to set the System in Reverse mode.

Press the button until **Z** indicator is lit.

Even when the reverse mode is set to **Z** before starting recording, the tape stops automatically at the end of the reverse side of tape. **Z** is indicated during recording.

3. Set a CD.

4. Press the CD ►/|| button to set the System function to CD.

If the System function is already set to CD, go to step 6.

5. Press the ■ button to stop the CD.

6. If you want to record specific tracks only, program the tracks.

You can check their total playback time on the display during programming. (See page 12.)

7. Choose whether to have pauses between recorded selections.

- If nothing is done, a non-recorded pause of about four seconds will be automatically left between selections.
- If you do not want pauses between selections, do the following before proceeding to the next step.
Press the CD ►/|| button twice to enter Pause mode.

8. Press the ONE TOUCH REC button on the Unit for more than two seconds.

The “REC” indicator lights up and the System starts recording.

- If you make a recording with Reverse mode on, the System will record the last song at the end of the first side onto the next side from its beginning when the song has been recorded more than 10 seconds on the first side.
If the last song has been recorded less than 10 seconds, then the previous song will again be recorded on the next side as it will not be completely recorded on the first side because of leader tape.
- After the CD Player has played the entire CD, or all the programmed tracks, the tape automatically stops.

To stop at any time during the recording process

Press the **■** button. The tape stops after four seconds.

Note:

When making SLEEP timer settings while doing CD Direct recording, set enough time to allow for the CD to finish playing, otherwise the power will go off before recording is completed.

One Track Recording

You can record the one CD track being played.

1. Insert a blank or erasable cassette tape into the Cassette Deck.

2. Play the track on the CD you wish to record.

3. Press the ONE TOUCH REC button on the Unit for more than two seconds.

The CD Player returns to the beginning of that track and the track is recorded on the tape. After recording, the CD Player and the Cassette Deck automatically stop.

Listening to an Auxiliary Equipment

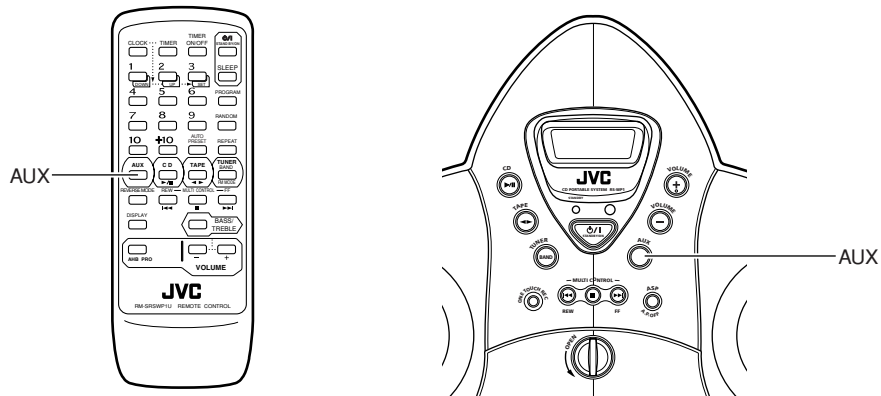

Listening to Auxiliary Equipment

You can listen to an auxiliary equipment.

- First make sure that the auxiliary equipment is properly connected to the System. (See page 4).

- 1. Set the volume level to minimum.**
- 2. Press the AUX button.**

“AUX” appears on the display.

AUX

- To listen to the auxiliary equipment, start playing the auxiliary equipment.

- 3. Adjust the volume to the desired listening level.**
- 4. Apply sound effects, if you wish.**

- Adjust the BASS/TREBLE to control the tone. (See “Active Hyper Bass Pro” and “Tone Control (BASS/TREBLE)” on page 8.)

Note:

For operation of the auxiliary equipment, refer to its Instructions.

Using the Timers

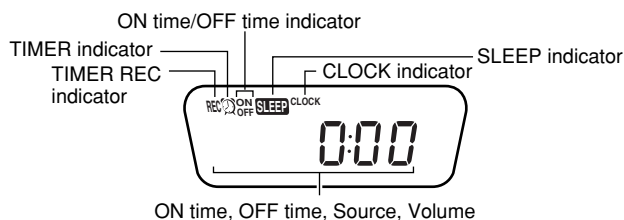
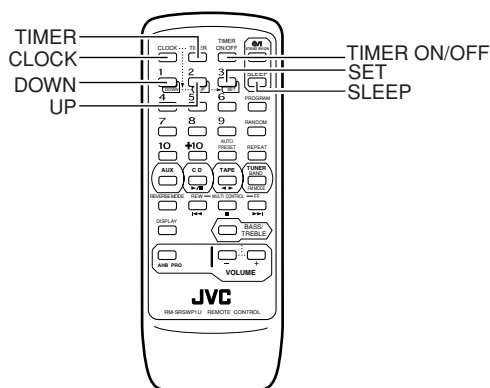

When the System is in use, the display shows other items as well. For simplicity, we show here only the items described in this section.

The timers let you control listening and recording functions automatically.

Setting the Clock

When you supply the power using one of the following ways, the "CLOCK" indicator blinks and "0:00" appears on the display. You need to set the clock.

- Plugging the AC adaptor into the wall outlet
- Loading 8 batteries into the Unit
- Connecting car battery (DC12V)

Use the Remote Control to set the clock.

Notes:

- The clock must be correctly set for the timers to work.
- The procedure must be completed within **two minutes**. Otherwise, the setting is cleared and must be repeated from the beginning.

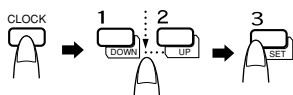

1. Turn on the System.

2. Press the CLOCK button on the Remote Control.

The time indication blinks on the display.

3. Press the UP or DOWN button to set the time.

Press the UP or DOWN button to increase or decrease the time. Pressing and holding the button will change the time rapidly.

4. Press the SET button.

The selected time is set and the seconds start counting from 0. Then, the display returns to the original one.

CAUTION: If no battery is loaded in the unit and it left with the AC adaptor unplugged (or when there is a power failure) for more than 5 minutes, CLOCK indicator will blink on the display. Set the current time (clock) again.

Setting the Timer

Once you have set the Timer, the timer will be activated at the same time every day, except for the Tuner REC timer which is used to record a broadcast on the tape. It can be cancelled and reactivated whenever you wish.

The Timer indicator (🕒) on the display shows when the Timer you have set is in effect.

Use the Remote Control to set the Timer.

Note:

Perform each setting within 30 seconds. Otherwise, setting is cleared and the procedure must be repeated from the beginning.

1. Turn on the System.

2. Setting the ON time (Example: 11:15).

1. Press the TIMER button on the Remote Control. The Timer indicator (🕒) and "ON" indicator light up and the current ON time blinks on the display.



2. Set the ON time by pressing the UP or DOWN button. Pressing and holding the button will change the time rapidly.



3. Press the SET button. The current OFF time blinks on the display.



(To be continued on the next page)

3. Setting the OFF time (Example: 13:30).

1. Set the OFF time by pressing the UP or DOWN button.
Pressing and holding the button will change the time rapidly.



2. Press the SET button.
The music source "TUNER" blinks on the display.

4. Selecting the music source.

1. Press the UP or DOWN button to select the music source you want to listen to. The display changes as follows:
TUNER→**TUNER REC**→**CD**→**TAPE**→(back to the beginning)
 - When you select the TUNER REC, the TIMER REC indicator appears on the display.
 - When you select the TUNER REC, the timer will be released after Tuner Recording has been finished.
2. Press the SET button.
The volume level set by the previous time setting blinks on the display.

5. Setting the volume level.

1. Press the UP or DOWN button to select the volume level.
--: The current volume level will be used.
0 to 50: When the timer is turned on, the Volume will be automatically set to the selected level.



2. Press the SET button.
The timer setting is completed and the display returns to the display before you set the timer. The Timer indicator (⌚) remains lit.

6. Before turning off the System, prepare the music source selected in step 4.

- TUNER:** Tune in to the desired station.
TUNER REC: Tune in to the desired station and insert a cassette tape for recording the station.
CD: Set a CD.
TAPE: Insert a tape.

7. Turn off the System.

- When the timer turns on, the volume level gradually increases from 0 (zero) to the preset level in step 5.
- To cancel the operation,** press the TIMER button until the display returns to the original one.
- To cancel the timer,** press the TIMER ON/OFF button. The Timer indicator (⌚) goes out on the display.
- To reactivate the cancelled timer,** press the TIMER ON/OFF button to light the Timer indicator (⌚).
- To confirm the timer settings,** press the TIMER button. Then, press the SET button repeatedly to see the current timer settings (ON time, OFF time, source, and volume).
- To change the timer setting,** repeat the setting procedure from the beginning.

Note:

It is recommended to power the System from the AC adaptor when you set recording by timer.

CAUTION: If no battery is loaded in the unit and it left with the AC adaptor unplugged (or power failure) for more than 5 minutes, timer settings will be erased from memory. If this happens, set the current time (clock) and perform the timer setting again.

Setting the Sleep Timer

Use the Sleep Timer to turn the System off after a certain number of minutes when it is playing. By setting the Sleep Timer, you can fall asleep to music and know that your System will turn off by itself rather than play all night.

- You can only set the Sleep Timer when the System is on and a source is playing.

1. Play a CD, tape, or tune in to the desired station.

2. Press the SLEEP button on the Remote Control.

The SLEEP indicator lights up on the display.



3. Set the length of time you want the source to play before shutting off.

- Each time you press the SLEEP button, it changes the number of minutes shown on the display in this sequence:
30 → **60** → **90** → **120** → Cancelled (Original display) → (back to the beginning)

After setting the number of minutes for the Sleep Timer, the display will stop blinking and return to the display as before setting the Sleep Timer.

The System is now set to turn off after the number of minutes you set.

To Confirm the Sleep Time:

When the SLEEP button is pressed, the remaining sleep time is displayed. Wait until the display returns to the original display.

To Cancel the SLEEP Timer Setting:

Press the SLEEP button until the original display appears on the display. Turning off the System also cancels the SLEEP Timer.

- If you are setting the Daily Timer, the System will be turned on at the set time to wake you up.

Care And Maintenance

Handle your CDs carefully, and they will last a long time.

Compact Discs

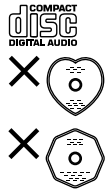

- Only CDs bearing this mark can be used with this System. However, continued use of irregular shape CDs (heart-shape, octagonal, etc.) can damage the System.



- Remove the CD from its case by holding it at the edges while pressing the case's center hole lightly.
- Do not touch the shiny surface of the CD, or bend the CD.



- Put the CD back in its case after use to prevent warping.
- Be careful not to scratch the surface of the CD when placing it back in the case.
- Avoid exposure to direct sunlight, temperature extremes, and moisture.



- A dirty CD may not play correctly. If a CD does become dirty, wipe it with a soft cloth in a straight line from center to edge.

CAUTION: Do not use any solvent (for example, conventional record cleaner, spray thinner, benzene, etc.) to clean a CD.

General Notes

In general, you will have the best performance by keeping your CDs and the mechanism clean.

- Store CDs in their cases, and keep them in cabinets or on shelves.
- Keep the System's door closed when not in use.

Cleaning the lens

If the lens in the CD pickup is dirty, dropout, etc., could degrade sound.

Open the door and clean the lens as shown.

- Use a blower (available from a camera store) to blow dust off the lens.

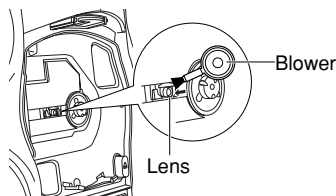

- If there are fingerprints, etc. on the lens, gently wipe clean with a cotton swab.

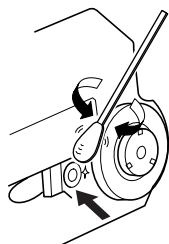

Moisture Condensation



Moisture may condense on the lens inside the System in the following cases:

- After turning on heating in the room.
- In a damp room.
- If the System is brought directly from a cold to a warm place.

Should this occur, the System may malfunction. In this case, leave the System turned on for a few hours until the moisture evaporates, unplug the AC adaptor, and then plug it in again.

Cassette Tapes



- If the tape is loose, it may get stretched, cut, or caught in the cassette. Take up the slack by inserting a pencil in one of the reels and rotating.



- Do not touch the tape surface.



- Do not store the tape:
 - In dusty places
 - In direct sunlight or heat
 - In moist areas
 - On a TV or speaker
 - Near a magnet

Cassette Deck

- If the heads, capstans, or pinch-rollers of the Cassette Deck become dirty, the following may occur:
 - Loss of sound quality
 - Discontinuous sound
 - Fading
 - Incomplete erasure
 - Difficulty recording
- Clean the heads, capstans, and pinch-rollers using a cotton swab moistened with alcohol.

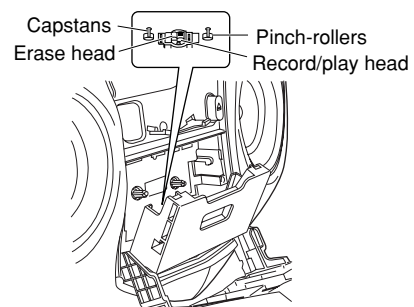

- If the heads become magnetized, the System will produce noise or lose high frequency notes.
- To demagnetize the heads, turn off the System, and use a head demagnetizer (available at electronics and record shops).

Troubleshooting

- If you are having a problem with your System, check this list for a possible solution before calling for service.
- If you cannot solve the problem from the hints given here, or the System has been physically damaged, call a qualified person, such as your dealer, for service.

Symptom	Possible Cause	Action
No sound is heard.	<ul style="list-style-type: none"> • Connections are incorrect, or loose. • Headphones are connected. 	<ul style="list-style-type: none"> • Check all connections and make corrections. (See page 4.) • Disconnect the headphones.
Unable to record.	Cassette record protect tabs are removed.	Cover the holes on the back edge of the cassette with tape.
Poor FM reception	The FM telescopic antenna is not properly extended and positioned.	Fully extend the FM telescopic antenna and turn it for the best reception.
The CD skips.	The CD is dirty or scratched.	Clean or replace the CD.
The CD does not play.	The CD is upside down.	Put the CD in with the label side up.
Unable to operate the Remote Control.	<ul style="list-style-type: none"> • The path between the Remote Control and the sensor on the Unit is blocked. • The batteries have lost their charge. 	<ul style="list-style-type: none"> • Remove the obstruction. • Replace the batteries.
Operations are disabled.	The built-in microprocessor has malfunctioned due to external electrical interference.	Unplug the System then plug it back in after a few minutes.
The cassette holder cannot be opened.	During tape playing, the AC adaptor was unplugged.	Plug in the AC adaptor and press the ⏻/I STANDBY/ON button.

Specifications

Amplifier

Output Power	
(Max.)	26 W (13 W + 13 W) at 4 Ω
(10% THD)	20 W (10 W + 10 W) at 4 Ω
Input Sensitivity/Impedance (1 kHz)	
AUX IN	380 mV/47 k Ω
Output Sensitivity/Impedance (1 kHz)	
Phones	16 Ω - 1 k Ω
	0 - 12 mW/ch output into 32 Ω

Cassette Deck

Frequency Response	
TypeII (CrO ₂)	60 Hz - 14 kHz
Wow and Flutter	0.15% (WRMS)

CD Player

Wow And Flutter	Unmeasurable
-----------------	--------------

Tuner

FM Tuner	
Tuning Range	87.5 MHz - 108.0 MHz
AM Tuner	
Tuning Range	522 kHz - 1 629 kHz
Antenna	FM telescopic antenna
	Ferrite core antenna for AM

Speakers

Full range	10 cm \times 2, 4 Ω
Passive cone	10 cm \times 2

General

Dimensions	411 mm \times 456 mm \times 234 mm (W/H/D)
Mass	5.1 kg (without batteries)
	5.9 kg (with batteries)

Accessories

AC adaptor (1)
Remote Control (1)
Batteries R6P (SUM-3)/AA (15F) (2)
Shoulder Strap (1)

Power Specifications

Power Requirements	DC 12 V ("R20/D (13F)" batteries (8))
	External DC 12 V (AA-R1211 AC adaptor or car battery via optional CA-R120E car adaptor)
Power Consumption	18 W (power on mode)
	1.3 W (in Standby mode)

Design and specifications are subject to change without notice.



JVC
VICTOR COMPANY OF JAPAN, LIMITED